

WARRANTY CARD

Model No. WG-105 Serial No.
WG-106
WG-107
C.M.No. Date of Sale.

Owner's Name & Address.
.....
.....

Tested By. Remarks.

AUTHORIZED DEALER/FRANCHISEE

COMPANY'S AUTHORIZED PRICE LIST FOR SPARES AVAILABLE WITH SERVICE FRANCHISEE

Marketed by:

Groupe SEB India (P) Ltd.

C-67, 3rd Floor, DDA Sheds, Okhla Phase 1, New Delhi-110020, India

For customer feedback and complaints, please contact:

Service Executive :

Groupe SEB India (P) Ltd.

C-67, 3rd Floor, DDA Sheds, Okhla Phase 1, New Delhi-110020, India

Tel : 011-43684999, 011-33684999, e-mail : maharajacare@groupeseb.com



**MAHARAJA
SERVICE APP**

www.maharajawhiteline.com

Follow us on :

MAHARAJA —WHITELINE—

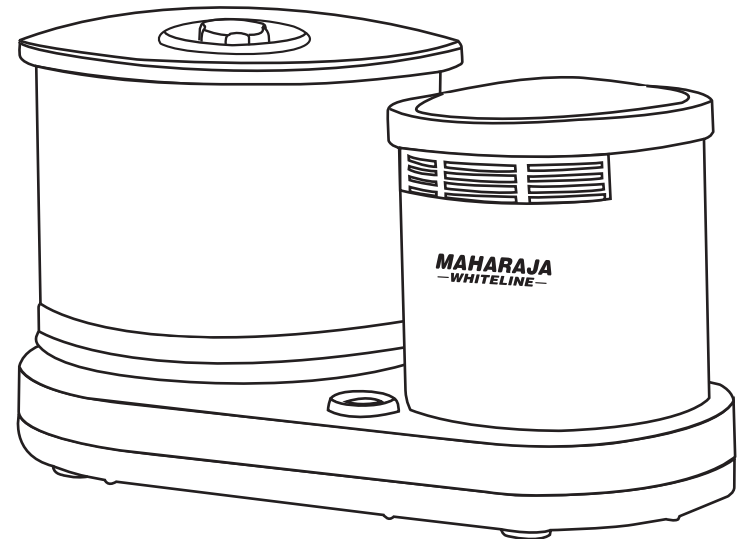

fortune cherry,
grindstone,
fortune dlx lavender,
Wet Grinder

INSTRUCTION MANUAL

PARTS DESCRIPTION

- A. Basic unit
- B. Lid
- C. Drum
- D. Roller Stone Assy
- E. Scraper blade*
- F. Atta kneader*
- G. lock nut

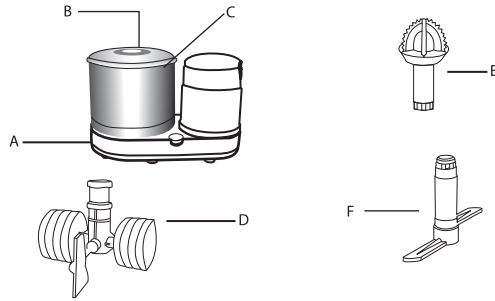

Please read these instructions before operating and retain for future reference.

SAFETY INSTRUCTIONS

1. Do not run the grinder if operating conditions are not normal. In case of any fault rush to your nearest authorised Maharaja Whiteline dealer. Do not attempt to repair it yourself.
2. Always keep the wet grinder away from heat sources.
3. Always keep the wet grinder clean and dry.
4. Always use the wet grinder as per instruction in this manual.
5. Disconnect the wet grinder after every use from mains.
6. Lift wet grinder from its base only.
7. Clean drum and stones assembly after every use.
8. Close supervision is necessary when wet grinder is in operation.
9. Store wet grinder in its carton box/covered when not in use for a long time.
10. Don't run wet grinder empty.
11. Don't put your hand in wet grinder when in operation.
12. Don't pour water on wet grinder for cleaning. Please use damp sponge for cleaning.
13. Don't lift wet grinder when in operation.
14. Don't use any attachment other than provided with wet grinder.
15. Don't insert any sharp objects in slits, it may damage internal parts.
16. Clean the drum multiple times with luke warm & soap water before first use. Pour little soap & luke warm water into the drum, close the lid and operate it for a few minutes. Then wash it with luke warm water till all traces of soap are washed away. Wipe the area with a soft cloth and then dry.

OPERATING INSTRUCTIONS

Please follow the instruction before operating Maharaja Whiteline wet grinder. It is recommended that medium which is to be ground, first to be soaked for four hours minimum. This will vary with quantity & quality of medium as per table shown below.

S.No.	Medium	Soaking Time
1.	Rice (Raw/Boiled)	4 hours min.
2.	Daal/Pulses (Urad, Toor etc.)	4 hours min
3.	Masala Mixture of onion, chilli, shredded, coconut. Ginger, Coriander, garlic, Jeera, Spices, etc.	not req.
4.	Greens	not req.

*Applicable with Grindstone & Fortune Dlx Lavender.

SEQUENCE OF OPERATION



1. Clean drum assembly thoroughly.

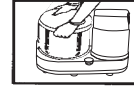

2. Place drum on centre rod. Gently rotate till drum fixes itself



3. Place the roller assembly in the drum & position to fit.

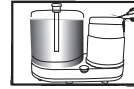

4. Tight the lock nut.



5. Pour a cup of water in the drum.

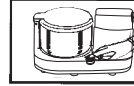

6. Press the switch downwards to turn on the appliance.



7. Add the grinding medium in small quantities with adequate water.

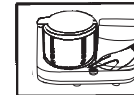

8. When required consistency is achieved, switch off the appliance.

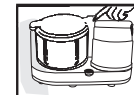

9. Unscrew the lock nut.



10. Remove roller assembly and wipe down batter.



11. Remove the drum and use required amount of batter. The rest can be stored in your refrigerator.

Additional Attachments *

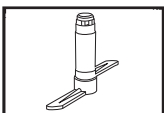

1. ATTA KNEADER *

This attachment kneads atta consistently & effectively for making roties, puries & paranthas soft & tasty.

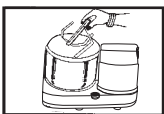

OPERATION *

Remove stone assy & place atta kneader attachment in drum by positioning as described earlier. Now lock nut & pour the atta (approx. 350gms.) Add a little water and switch "on" wet grinder. Add a little oil and salt to taste. Add sufficient water to get required kneading consistency.

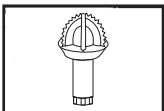

2. COCONUT SCRAPER *

This attachment scrape coconuts consistently & effectively for making soft and tasty chutnies.

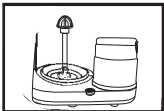

OPERATION *

Fix scraper blade on center sleeve of vessel. Take half part of coconut & hold it firmly on the blade. Now switch "on" wet grinder. When scraping is complete. please see that no coconut chips are struck to blade in the corner. Now remove scraper blade .

Trouble	Reason	What to do
Basic unit doesn't run	No power supply	Check mains.
Basic unit starts, but stops suddenly	1. Overloading of drum 2. Insufficient water	Remove medium and add in small quantities add water as reqd.
Basic unit is noisy	Wrong wiper position	Check position
Increase in grinding time	Excess Qty. insufficient soaking time, wiper position incorrect	Check
Basic unit overheating	1. Low voltage 2. Air vents locked 3. External heat source	Operate at 220v 50 Hz clean air vents Check
Vibration	Uneven platform	Check
Basic unit/Drum smells	1. Motor burnt 2. Drum/stone assy. dirty	1. Call service 2. clean
Basic unit cycles on/off	Faulty switch	Call service
Stones not rotating	1. Not cleaned properly 2. Excess loading 3. Stones stuck on pin.	Clean under water remove extra load unscrew stones pin and clean.

*Applicable with Grindstone & Fortune Dlx Lavender.

TECHNICAL DATA

Capacity of drum	: 2 Litre (soaked medium)
Wattage	: 150W
Power supply	: 230 volts/50Hz AC
Direction	: Clock Wise
Additional attachment *	: Atta Kneader blade*, Coconut Scrapper Blade.*
Weight	: Fortune Dlx Lavender 10.7kg, Grindstone 10.7kg, Fortune Cherry 10.5kg

WARRANTY TERMS AND CONDITIONS

The Company offers 2 year product warranty and 5 year motor warranty, for this product for repairing or replacing parts, free of cost against defect in manufacturing functional part subject to the following terms and conditions.

- The warranty is valid only if this card is duly signed and stamped by our dealer and is produced along with the original customer's copy of the purchase bill.
- Warranty period starts from the date of purchase from our authorized dealer only.
- The Appliance has to be used with all normal care and maintenance and in accordance with instructions for use, recommended by the company, as enumerated in the instruction manual.
- The Appliance should not be repaired, tampered or altered by any agency or person other than an authorised company personnel or their service centers.
- The warranty shall not apply to replacements parts such as Main Cords.
- Plastic parts, which are breakable, are not covered under this warranty.
- The Appliances subject to normal wear & tear, misuse, neglect, accident including technical breakdown etc. or non compliance of the instructions given in the instruction manual, improper installation is not covered by this warranty.
- The customer is responsible for bringing the defective product to the service centre/manufacturer for servicing and collecting the same at his/her own cost.
- The Appliance is meant for domestic use only.
- Parts repaired or replaced under this warranty are warranted only for the remainder of the original warranty period, that is no fresh warranty period shall commence for the said replaced/repaired part.
- Liability under terms of warranty is limited to the value of the repairs/replacement of the parts found to be defective with in the warranty period. All parts may have been replaced shall have been replaced shall become the property of the company.
- Under the terms of warranty, installation, free service will be provided only within the municipal limits of the cities/towns where the company has its branches or authorized representatives. Service outside the municipal limits specified above will be provided after charging the actual to and fro traveling and incidental expenses, as prevailing from time to time.
- The decision of the company is final and binding on all matters arising out of this warranty.
- This warranty is issued at Delhi, and courts at Delhi shall have exclusive jurisdiction over matters by or following from this warranty. In case of any dispute, arising out of this the same shall be settled by an Arbitrator, In accordance with the provisions of Arbitration and conciliation Act, 1996.

*Applicable with Grindstone & Fortune Dlx Lavender.